MyCycler™ Thermal Cycler

Instruction Manual

**Catalog Number
170-9703**



Safety Information

Notice to Purchaser

Purchase of this instrument, Serial No. _____, conveys a limited non-transferable immunity from suit for the purchaser's own internal research and development and for use in applied fields other than Human In Vitro Diagnostics under one or more of U.S. Patents Nos. 5,656,493, 5,333,675, 5,475,610 (claims 1, 44, 158, 160-163 and 167 only), and 6,703,236 (claims 1-7 only), or corresponding claims in their non-U.S. counterparts, owned by Applera Corporation. No right is conveyed expressly, by implication or by estoppel under any other patent claim, such as claims to apparatus, reagents, kits, or methods such as 5' nuclease methods. Further information on purchasing licenses may be obtained by contacting the Director of Licensing, Applied Biosystems, 850 Lincoln Centre Drive, Foster City, California 94404, USA.

The sample block of the MyCycler thermal cycler can reach temperatures of 100°C, and the heated lid can be programmed to maintain temperatures up to 110°C. The heated lid should remain closed at all times during operation to prevent accidental skin burns. Always allow the sample block to return to its idle temperature before opening the lid and removing samples. When placing or removing samples, open the heated lid all the way up to allow maximum clearance and to avoid accidental skin burns.



This symbol on the reaction module indicates a hot surface.

Always connect the power supply to a 3-prong, grounded AC outlet rated 10 A/100–120 V or 5 A/220–240 V using the AC power cord provided with the MyCycler. Do not use an adapter to a two-terminal outlet. Before plugging the instrument in, be sure that the correct fuse is installed in the rear panel fuse holder. Use the 4A 5 x 20 mm TYPE T fuse for 220–240 V or the 8A 5 x 20 mm TYPE T fuse for 100–120 V.

Never remove the outer casing of the MyCycler. There are no user-serviceable parts for this instrument. Call your local Bio-Rad office for instrument services.

To insure adequate cooling of the MyCycler, place it on a clean, flat surface, and be sure that there is at least 4 inches (10 cm) clearance around each side of the thermal cycler. Make sure that the bench space is free of any foreign objects or debris that could block the fan vents.

Do not operate the MyCycler in extreme humidity or where condensation can short the internal electrical circuits of the thermal cycler.

Notice

This Bio-Rad instrument is designed and certified to meet EN-61010 safety standards. EN-61010 certified products are safe to use when operated in accordance with the instruction manual. This instrument should not be modified in any way. Alteration of this instrument will:

- Void the manufacturer's warranty,
- Void the EN-61010 safety certification,

- Create a potential safety hazard.

Bio-Rad is not responsible for any injury or damage caused by use of this instrument for purposes other than those for which it is intended, or by modifications of the instrument not performed by Bio-Rad or an authorized agent.

This product conforms to the "Class A" standards for electromagnetic emissions intended for laboratory equipment applications. It is possible that emissions from this product may interfere with some sensitive appliances when placed nearby or in the same circuit as these appliances. The user should be aware of this potential, and take appropriate measures to avoid interference.

This instrument is intended for research applications only.

Table of Contents

	Page
Section 1 Introduction	1
1.1 Overview	1
1.2 Features	2
1.3 System Setup	2
1.3.1 Unpacking	2
1.3.2 Fuse Installation and Power Cable Connection	3
1.3.3 USB Cable Connection	4
1.3.4 Powering Up and Shutting Down	4
1.3.5 Standby Mode	4
1.4 Recommended Tubes and Plates	5
1.5 MyCycler Keypad	5
1.6 What's in this Manual	8
Section 2 Quick Guide for Running the MyCycler	9
Section 3 The Home Screen	10
3.1 Soft Key Functions for the Home Screen	10
Section 4 Thermal Cycling Protocols	11
4.1 Overview	11
4.2 The Protocol Library Screen	11
4.2.1 My Protocols	11
4.2.2 Bio-Rad Protocols	11
4.2.3 Protocol Options	12
4.2.4 Soft Key Functions for the Protocol Library	12
4.3 Protocol Parameters	13
4.3.1 Basic Programming Options	13
4.3.2 Advanced Programming Options	13
4.3.2.1 Increment/Decrement Temperature	13
4.3.2.2 Increment/Decrement Time	14
4.3.2.3 Temperature Gradient	14
4.4 Graphical Representation	14
4.5 Viewing Protocols	16
4.5.1 Soft Key Functions for the View Screen	16
Section 5 Creating and Editing Protocols	17
5.1 Specifying Time Values	17
5.2 Specifying Temperature Values	17
5.3 Specifying Cycle Repeats	17
5.4 Creating and Editing Protocols: Advanced Options	18
5.4.1 Temperature and Dwell Time Options (F3-Option)	18
5.4.2 Temperature Gradient	19
5.4.3	20
5.4.4 Changing the Number of Cycles or Steps (F4-Add/Del)	21
5.5 Soft Key Functions for the Edit Screen	21
5.6 Completing Protocols	21
5.7 Naming a Protocol	22
Section 6 Running Protocols	23
6.1 How to Run a Protocol	23

6.1.1	Run Setup Screen	23
6.1.2	Run Screen.....	24
6.1.3	Running Gradient Protocols	25
6.1.4	Converting a Gradient Protocol	25
6.2	Options While a Protocol is Running	26
6.2.1	Displaying the Home Screen while a Protocol is Running	26
6.2.2	A Power Failure while a Protocol is Running	26
6.2.3	Pausing a Running Protocol.....	27
6.2.4	Terminating a Running Protocol.....	27
6.2.5	End of Run Screen.....	27
Section 7	Reports	28
7.1	The Run Report	28
7.2	The Validation Report	28
7.3	Soft Key Functions for Reports	28
7.4	Uploading Reports	29
Section 8	Utilities	30
8.1	The Utilities Menu	30
8.1.1	View Reports	30
8.1.2	Instrument Information	30
8.1.3	Set Date and Time	30
8.1.4	Set Display Contrast	30
8.1.5	Service Options	30
8.2	The Set Preferences Menu	30
8.2.1	Default Hot Start Options	30
8.2.2	Default Temperature Measurement Mode.....	31
8.2.3	Default Sample Volume	31
8.2.4	Idle Temperature Measurement Mode	31
8.2.5	Lid Temperature Control	31
8.2.6	Auto-Standby Options.....	31
8.2.7	Instrument Name	32
8.2.8	Beeper Options.....	32
Section 9	The Help Screen	33
9.1	Soft Key Functions for the Help Screen.....	33
Section 10	Care and Maintenance	33
10.1	Cleaning the Unit	33
10.2	Replacing a Fuse or a Battery.....	33
10.3	Troubleshooting Procedure.....	34
10.4	Error Messages	35
Appendix A	Specifications	36
Appendix B	Product Information.....	38

Section 1

Introduction

1.1 Overview

The Polymerase Chain Reaction (PCR) has been one of the most important developments in Molecular Biology. This technique has greatly accelerated the rate of genetic discovery, making critical techniques relatively easy and reproducible.

The MyCycler thermal cycling instrument provides optimum performance for PCR and other thermal cycling techniques. The MyCycler incorporates a Peltier driven heating and cooling system for superb thermal cycling performance. See **Appendix A-Specifications** at the end of this manual for detailed information regarding the rates of heating and cooling, and accuracy and uniformity of the reaction module's temperature. Rigorous testing of the module's accuracy, uniformity, and consistency in temperature, and of heating and cooling rates was conducted to insure reliable and reproducible experimental results.

The MyCycler features a heated lid. This eliminates the need for any oil overlay in the sample tubes as long as lid temperature control is on and the lid remains closed throughout the run. The self-adjusting, heated lid provides the versatility to accommodate a variety of tubes or plates.

The MyCycler offers two modes of temperature monitoring and control:

- Algorithm – uses the experimentally derived sample temperature given a specific sample volume
- Block – uses the actual sample block temperature

Both modes of temperature control yield excellent results in our test protocols.

The MyCycler comes with an exceptionally intuitive user interface, offering a graphical view of the programmed protocols. Each protocol may include as many as 9 cycles with 9 steps each and up to 99 repeats for each cycle. Additionally, the MyCycler is capable of advanced protocol options such as time and temperature increments and decrements. Furthermore, every time a protocol is executed, a detailed report of the run is recorded and stored on the instrument for 30 days.

* Practice of the polymerase chain reaction (PCR) process requires a license. The MyCycler is an authorized thermal cycler, and may be used with PCR licenses available from Applied Biosystems. Its use with authorized reagents also provides a limited PCR license in accordance with the label rights accompanying such reagents.

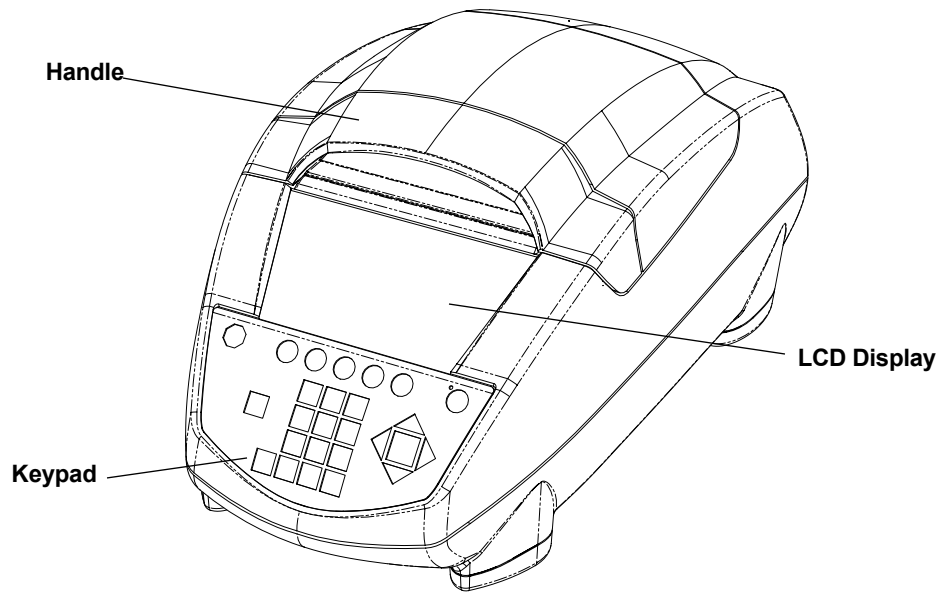

1.2 Features

- Self-adjusting lid and reaction module design accommodate 0.2 ml tubes, strips, and 96-well plates.
- Graphical representation of thermal cycling protocols.
- User-friendly software, including menu driven software, ready-made protocol templates and user-defined preferences.
- Run status and history are recorded in run reports and validation reports.
- Optional sleep mode saves power when the instrument is not in use.
- USB port enables users to transfer and print protocols or reports with a host computer connected to the instrument and a printer.
- Compact design saves bench space.
- Temperature monitoring and control can be specified by instrument algorithm or reaction module block mode.
- NIST-traceable temperature performance.

1.3 System Setup

1.3.1 Unpacking

The MyCycler is shipped in one box containing the following:

- MyCycler thermal cycler
- Power cord
- Instruction Manual
- Fuses
- USB cable for PC interface
- MyCycler utility CD-ROM

Carefully remove the contents of the shipping box. To remove the thermal cycler, lift it out by grasping the underside of the unit. Remove the plastic bag and inspect the instrument for any external damage. Check off all parts against the supplied packing list.

Your MyCycler was carefully tested at the factory and was shipped in good working order. If any part is missing or damaged, contact Bio-Rad Laboratories immediately.

1.3.2 Fuse Installation and Power Cable Connection

Your MyCycler is configured for 100 to 240 V. You should install the correct fuse using the following procedure:

Warning: Failure to follow this procedure may result in damage to the unit and invalidation of the warranty.

1. Disconnect the power cord from the unit.
2. Remove the fuse holder from the rear panel of the instrument with a small flat-head screwdriver or similar tool.
3. Pull the fuse holder out and install the correct fuse. The MyCycler comes with the following two fuses:
 - a. For 100–120 V operation: Use 8.0A, 5 x 20 mm, Type T fuses.
 - b. For 220–240 V operation: Use 4.0A, 5 x 20 mm, Type T fuses.
4. Reinsert the fuse holder into the rear panel of the instrument, and press the fuse holder gently until it snaps into place.
5. Insert the power cord plug into the power entry module. Plug the power cord into a properly grounded outlet.

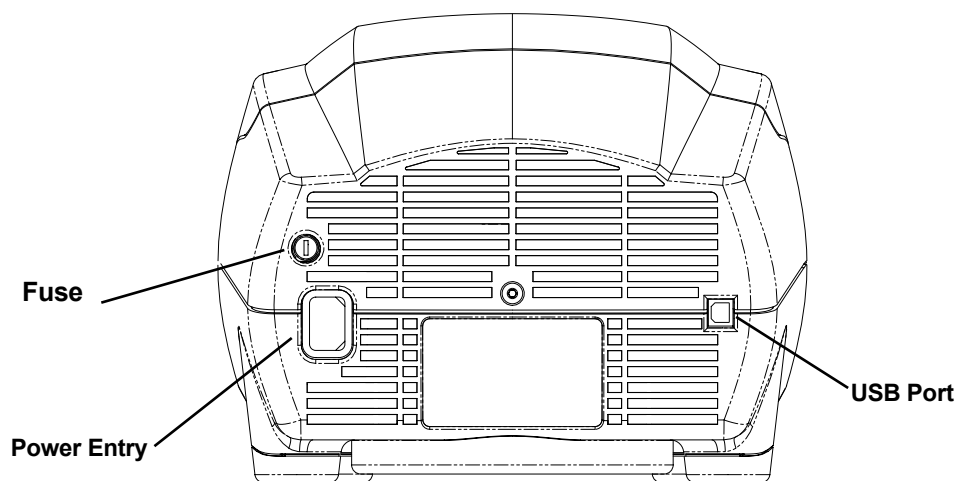

1.3.3 USB Cable Connection

In addition to the power cable connector, the rear panel of the MyCycler contains a USB port that may be connected to a personal computer, allowing the transfer of protocol files, **Validation Reports**, and **Run Reports**. Using this link, you may print out any downloaded protocols or reports if the PC is connected to a printer. The USB link is not necessary for running the instrument.

1.3.4 Powering Up and Shutting Down

Before powering up the MyCycler, place it in a location that has sufficient ventilation and access to the reaction module and keypad. We recommend at least 4" (10 cm) clearance to the left, right, and rear of the instrument. For convenience, about 14–15" (36–38 cm) clearance from the bench surface is needed to open the lid.

To turn the MyCycler on, press the "Standby" button on the front panel of the instrument once. A green LED next to the Standby button glows when the instrument is on and receiving power. To shut down the MyCycler completely, simply unplug the power cord from the power outlet. An alternative to system shutdown is **Standby mode**.

1.3.5 Standby Mode

To conserve power, the MyCycler has a user-programmable standby option. The green LED next to the Standby button blinks to indicate that the MyCycler is in **Standby mode**. This option will turn off all non-essential operations in an idle instrument, including the LCD screen, heated lid, and sample block temperature control. The fan will turn-off when the internal temperatures have equilibrated. Auto-Standby settings for the instrument may be programmed as described in Section 8.2.6. When in Standby mode, briefly press the Standby button once to turn the instrument back on.

Standby mode can also be initiated by holding down the blue Standby button once for 3 to 4 seconds. The instrument will go into Standby mode unless you are running a thermal protocol or have made unsaved changes to a protocol. If you are running a thermal protocol or have made unsaved changes to a protocol, you will be asked to verify the standby selection.

Note: Acceptance of standby initiation will terminate or abandon edits for the active protocol.

1.4 Recommended Accessories

For optimal performance of the MyCycler, we recommend Bio-Rad tubes, plates, and accessories as follows:

Catalog Number	Product Description
TWI-0201	0.2 ml Tubes With Domed Caps , natural, 1,000
TFI-0201	0.2 ml Tubes With Flat Caps , natural, 1,000
TBS-0201	0.2 ml 8-Tube Strips Without Caps , natural, 125
TCS-0801	Domed 8-Cap Strips , for 0.2 ml tubes and plates, natural, 120
TCS-0803	Optical Flat 8-Cap Strips , for 0.2 ml tubes and plates, ultraclear, 120
TBS-1201	0.2 ml 12-Tube Strips Without Caps , natural, 100
TCS-1201	Domed 12-Cap Strips , for 0.2 ml tubes and plates, natural, 200
MLP-9601	Multiplate 96-Well 0.2 ml Unskirted PCR Plates , natural, 25
MSB-1001	Microseal 'B' Adhesive Seals , 100
223-9442	96-Well PCR Plate Sealing Mats , 5
170-8870	<i>iTaq</i> DNA Polymerase , includes 250 U polymerase, 10x PCR buffer and MgCl ₂ solution
170-8872	MgCl₂ Solution , 1.25 ml of 50 mM MgCl ₂
170-8874	dNTP Solution , 200 µl of 10 mM of each dNTP

The recommended sample volume for 0.2 ml tubes or 96 well plates is 15–100 µl.

Note: When using individual 0.2 ml tubes in the MyCycler, place at least 10 tubes in the reaction block (in wells A1, A4, A9, A12, E1, D12, H1, H4, H9, and H12) to ensure that the tubes are not deformed over the course of the protocol

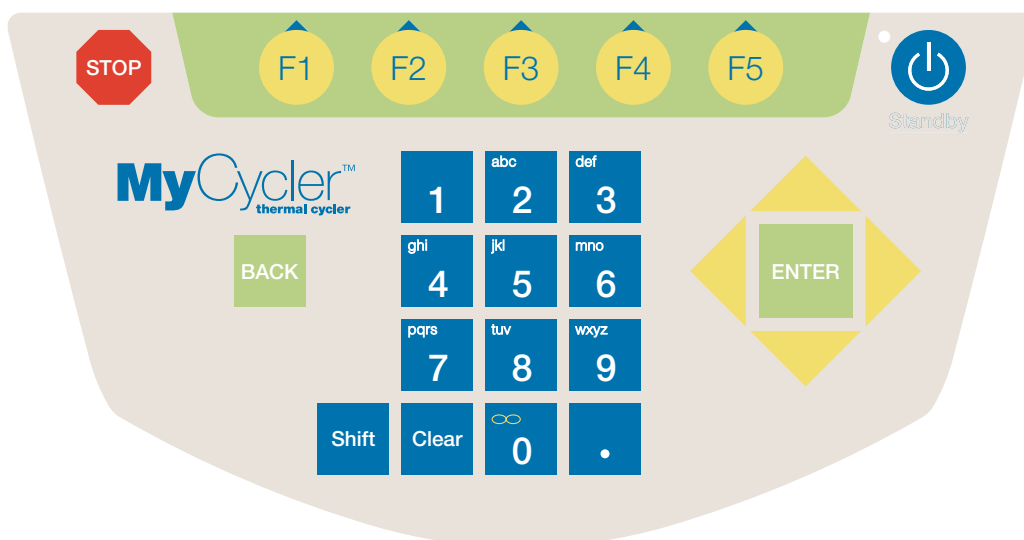

1.5 MyCycler Keypad

The MyCycler keypad has 26 keys on the front panel. These keys are described in the following table (Table 1):

Table 1. Front Panel Controls

Key(s)	Description
Softkeys F1-F5	The five function keys (referred to as “softkeys”) are labeled F1 through F5 . These keys are used to navigate through the software screens and make selections in the screen displays. The operations associated with these keys are displayed in inverse video immediately above the softkey. These operations change as the display changes. For example, in the Home screen, the F1 softkey will take you to the Protocol Library , and the F2 softkey will enable you to Create a protocol.
Back	<p>The Back key will return you to the immediately previous screen or, depending on the context, to some other, more appropriate previous screen. From most places in the firmware you can repeatedly press Back until, eventually, you return to the Home screen. When the Home screen is displayed, the Back key has no further function.</p> <p>When menus or option boxes are presented, Back acts as a Cancel key.</p>
Alphanumeric Keys	<p>Centered below the display are ten alphanumeric keys (keys 0-9), which are arranged like the keys on a telephone. Each numeric key (except 1 and 0) is used to represent three or more letters.</p> <p>The alphanumeric keys are usually used as number keys for the entry of time, temperature, and cycle repeats.</p> <p>When entering a protocol or instrument name into a screen display, the keys automatically shift to alpha mode for the entry of letters. The word ALPHA is displayed in the top right corner of the screen. You can toggle between alpha and numeric by pressing the Shift key. To enter uppercase letters, press F2-Caps Lock before pressing the alphanumeric key.</p> <p>To specify an alphabetic character, press the key until the desired character is displayed. For example, the 2 key is used for a, b, or c entries. To input the letter a, press the 2 key once. To input b, press the 2 key twice and to input c, press the 2 key three times. If the 2 key is pressed a fourth time, it will display the letter a.</p>
. (Decimal Point)	When entering numeric decimal values, press this key to enter values after the decimal.
∞ (Infinity)	The 0 key is labeled with an infinity symbol above the 0 to indicate that it has a secondary function of Infinite Dwell Time. Like the alphabetic characters, this secondary function is accessed by first pressing the Shift key. The Infinity key is used to indicate dwell times that are to be terminated by user intervention.

Typically this feature is used at the end of a protocol, but it can be used at other points as well. When an infinite dwell time is specified, the MyCycler will pause the protocol at the selected temperature until you terminate or resume execution.

Clear	The Clear key is used to clear the entire entry in an input field. For example, if you have specified an incorrect duration for a step, pressing the Clear key erases the entire entry, not just the last character entered.
Shift	The Shift key is located to the left of the alphanumeric keys. The Shift key is used in conjunction with the alphanumeric keys to switch between alphabetic and numeric character (see the discussion above for the alphanumeric keys), when naming a protocol or instrument.
Directional Arrows <, >, ^, v	<p>The four Directional Arrow keys surround the Enter key and direct the cursor when navigating the screen. Normally the right and left arrows are used to move from field to field, not within a field. The exception is the case when you are assigning a protocol or instrument name using the alphanumeric keys: in this instance the right and left arrows move the cursor within the name field and the only way to move out of the field is with the Enter key.</p> <p>The up and down arrows are used to move the cursor from line to line within selection boxes, or from one field to field when editing or creating protocols. In some of the Utilities screens, the up and down arrows are used to set the time, date, and default conditions. When a time or temperature field has a default value and that field is highlighted, pushing an arrow key is an implied Enter, accepting the default entry.</p>
Enter	In the middle of the arrow keys is the Enter key. When you press Enter the current selection or input field is accepted.
Stop	Below the LCD screen and to the left of the F1 softkey is the Stop key. If the Stop key is pressed while a protocol is running, the protocol will be paused (as described in section 6.2.3). Pressing the Stop key again, while the protocol is paused will terminate the protocol.
Standby	When the instrument is in Standby mode, pressing the Standby key once turns the instrument back on. When the instrument is on, holding the Standby key for 3 to 4 seconds puts the instrument into Standby mode. A warning will appear if you attempt to initiate Standby mode while running a protocol, or when unsaved changes have been made to a protocol.

1.6 What's in this Manual

This manual is organized into the following sections.

- **Section 1, Introduction:** This chapter provides an overview of the instrument and how to set it up.
- **Section 2, Quick Guide for Running the MyCycler:** This chapter is a quick guide for the user that wants to start running the MyCycler immediately.
- **Section 3, The Home Screen:** This chapter describes the **Home** screen and the functions associated with it.
- **Section 4, Thermal Cycling Protocols:** This chapter describes how to use the **Protocol Library**, as well as the parameters, organization, and layout of thermal cycling protocols.
- **Section 5, Creating and Editing Protocols:** This chapter explains how to use the **Edit** screen, and the process of creating and editing protocols.
- **Section 6, Running Protocols:** This chapter provides instructions on how to run any protocol. This includes a number of options for controlling the execution and monitoring the progress of the protocol.
- **Section 7, Reports:** This chapter describes **Validation reports** and the **Run reports** in detail, and explains how to read them.
- **Section 8, Utilities:** This chapter describes the features of the **Utilities** screen. This screen supports a number of features for customizing the environment.
- **Section 9, The Help Screen:** This chapter describes how to access and use the MyCycler's onboard help screens.
- **Section 10, Care and Maintenance:** This chapter provides information on cleaning the unit, replacing fuses, a troubleshooting guide, and a list of error messages.
- **Appendix A, Specifications:** This appendix provides the MyCycler system specifications.
- **Appendix B, Warranty:** This appendix includes the MyCycler warranty and technical support information.
- **Appendix C, Product Information.**

Section 2

Quick Guide for Running the MyCycler

The following procedure is provided for the user wishing to immediately start using the MyCycler. Detailed information for using the instrument is provided in subsequent sections.

1. Power up the MyCycler by either plugging in the instrument or, pressing the **Standby** key on the front panel of the instrument, if in Standby mode. After a quick diagnostic routine, the **Home** screen will be displayed.
2. Press **F2-Create** from the Home Screen. A selection menu will appear.
3. Select the "Custom" option from the selection menu (it should be selected by default) and press **Enter**. You may also choose to edit a Bio-Rad template protocol listed in this menu if the template protocol is similar to your desired protocol.
4. Edit the fields of the protocol.
 - The default, custom protocol is a simple three-step amplification protocol; 30 seconds at 95°C, 30 seconds at 55°C, followed by 0 seconds at 72°C.
 - To add or delete a step or cycle, press **F4-Add/Del** and select the appropriate option. Note that vertical lines demarcate different cycles, and that steps within the same cycle are not separated by vertical lines. Cycles are numbered sequentially in the bottom left corner of their first step's display.
 - Use the arrow keys to move the selection box between the different fields for each step of your protocol. Set point temperature fields are shown immediately above the temperature plot line, whereas dwell time fields are shown immediately below the temperature plot line. The repeats field, which specifies the number of times a cycle is to occur, followed by an "x", is shown in the bottom right corner of the last step of a cycle.
 - To add an increment or decrement option for either time or temperature put the selection box on the desired time or temperature field, press **F3-Option**, and select the desired option. After selecting the desired option, a new field will pop up in the display. In this new field, input the amount of time or degrees Celsius by which you want to increment or decrement each repeat.
 - When you are finished editing the protocol, press **F5-Done**.
5. Save the protocol by choosing "Save Protocol As..." from the selection menu. Name the protocol using the **alphanumeric** keys, as described in section 1.5, and press **Enter** when finished.
6. The **Home** screen will appear. Press the **F1-Protocol Library** to access the **Protocol Library**. Using the arrow keys, select the protocol you just created and press **Enter**. A selection menu will appear. Select "Run Protocol".
7. The **Run Setup** screen should appear. Specify whether or not you want a hot start (and the hot start temperature if you picked "YES"), and which temperature measurement mode you want (and the sample volume if you picked "Algorithmic Measurement").
8. Press **F5-Begin Run** to begin the run.

Section 3 The Home Screen

The **Home** screen is the first screen displayed after the instrument is turned on and finishes its self-diagnostic routine. The Home screen serves as a starting place for all functions of the interface and can be accessed from most other screens via the **F4-Home Screen** softkey, even while running a protocol. The Home screen also displays the current date and time, as well as the user-defined instrument name. The default name is the instrument's serial number. The date, time, and instrument's name may all be configured in **Utilities**. (see Section 8.1 **Utilities**)

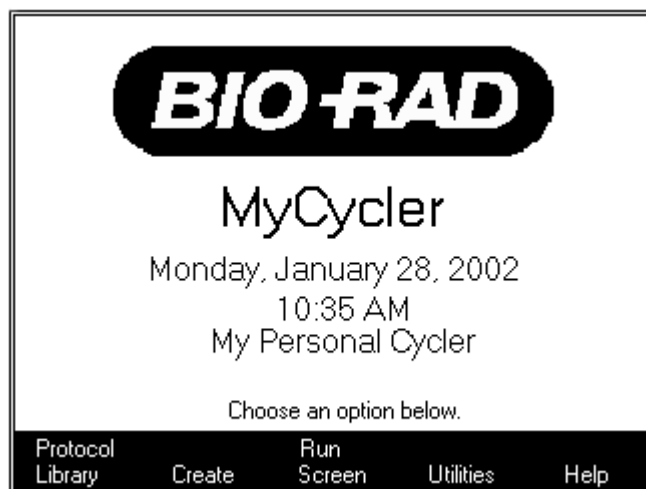

3.1 Soft Key Functions for the Home Screen

Softkey	Option	Description
F1	Protocol Library	Displays the Protocol Library screen, allows access to all saved protocols
F2	Create	Displays a menu of Bio-Rad protocol templates. Select either the protocol template most similar to the desired protocol to begin editing, or select Custom to create a new protocol from scratch
F3	Run Screen	Displays the Run screen, used to monitor the current run-status of the MyCycler
F4	Utilities	Displays the Utilities screen, select this option to alter instrument settings or for other miscellaneous functions
F5	Help	Displays the Help screen. You may browse through an onboard collection of help topics

Section 4 Thermal Cycling Protocols

4.1 Overview

Thermal cycling protocols contain the temperature cycling information to direct the MyCycler. A protocol is made up of as many as nine **cycles**, and a cycle is made up of as many as nine **steps**. A step is defined by specifying the set point temperature and dwell time at that temperature. A cycle is defined by specifying the times and temperatures for all steps and the number of times the cycle is repeated. The MyCycler comes with a set of predefined Bio-Rad protocols in the **Protocol Library**. You may also create new protocols by modifying any existing protocol in the library, including the Bio-Rad protocols, or you can create a new protocol from scratch.

4.2 The Protocol Library Screen

The Protocol Library screen contains the list of all thermal protocols saved on the instrument. All user-defined protocols appear on the left-hand side of the screen in the column labeled "My Protocols". Bio-Rad template protocols appear on the right-hand side of the screen in the column labeled "Bio-Rad". Use the arrow keys to select a protocol and then press **Enter** for more options. (See Section 4.2.3 **Protocol Options**)

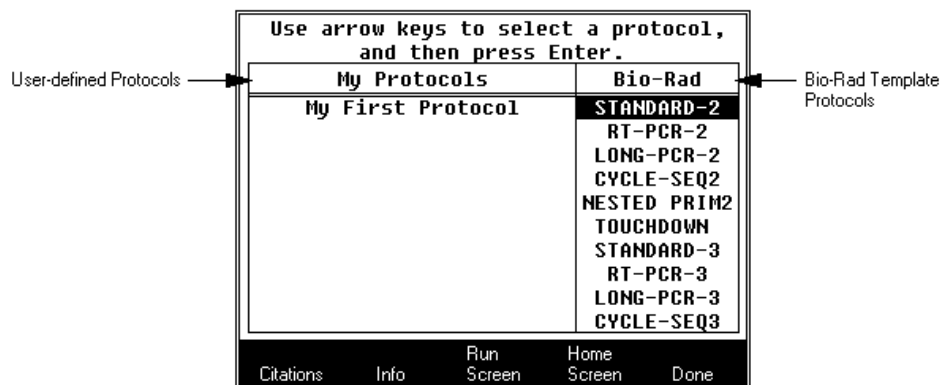

4.2.1 My Protocols

User-defined protocols are displayed in the **Protocol Library** under the column labeled "**My Protocols**". The MyCycler has sufficient memory to store up to 99 total protocols in the library. You may run, view, edit, delete, or rename any of these protocols listed in the **My Protocols** column.

4.2.2 Bio-Rad Protocols

Bio-Rad protocols are displayed in the **Protocol Library** under the column labeled "**Bio-Rad**". These protocols serve as templates for several different PCR applications. These include standard PCR, reverse transcriptase PCR (RT-PCR), nested primer PCR, PCR with temperature gradients, long PCR, touchdown PCR, and cycle sequencing PCR. These Bio-Rad protocols may be run directly, or modified as needed prior to running or saving. If you wish to modify a Bio-Rad

protocol and save the resulting protocol, you must use the "Save As" option and specify a new name. Bio-Rad protocols cannot be overwritten or deleted.

4.2.3 Protocol Options

After selecting the desired protocol and pressing **Enter**, you are presented with the following choices:

- **Run Protocol:** The **Run Setup** screen is displayed. (See section 6.1.1.)
- **View Protocol:** The protocol is displayed in the **View** screen. (See section 4.5.)
- **Edit Protocol:** The protocol is displayed in the **Edit** screen. (See section 5.)
- **Delete Protocol:** (Option only available for a user-defined protocol.) You will be asked to confirm that you want to delete the selected protocol from memory. Select **YES** to delete the protocol or select **NO** to keep the protocol.
- **Rename Protocol:** (Option only available for a user-defined protocol.) You will be asked to input a new name for the selected protocol. Protocol names are limited to 25 characters. Duplicate protocol names are not allowed.

4.2.4 Soft Key Functions for the Protocol Library

Softkey	Option	Description
F1	Citations/PageUp	<p>The Citations option is available when the cursor is in the Bio-Rad template column. This displays a short list of citations that describes the currently selected Bio-Rad protocol.</p> <p>The PageUp option is available when the cursor is in the My Protocols column. This scrolls the My Protocols column up one page from the current page.</p>
F2	Info/PageDown	<p>The Info option is available when the cursor is in the Bio-Rad column. This displays a short description of the currently selected Bio-Rad protocol.</p> <p>The PageDown option is available when the cursor is in the My Protocols column. This scrolls the My Protocols column down one page from the current page.</p>
F3	Run Screen	Displays the Run screen
F4	Home Screen	Displays the Home screen
F5	Done	Displays more options for the selected protocol.

4.3 Protocol Parameters

4.3.1 Basic Programming Options

- **Set point temperature:** Temperatures between 4.0°C and 100.0°C may be entered.
- **Dwell time:** Finite dwell times may be as long as 99 minutes and 59 seconds (99:59), or may be set as short as 0 seconds (00:00).

When the dwell time is set to 00:00, the MyCycler will heat or cool until it attains the **set point temperature** and then immediately begin heating or cooling to the next set point temperature.

Infinite dwell times may be programmed for any steps belonging to a cycle with only one repeat. When an infinite dwell time is reached, the instrument maintains the specified temperature until you intervene. If the infinite dwell time is programmed for any step other than the last step of the protocol, the instrument goes into **Pause** mode when it reaches that step, and holds the set point temperature until you press the **Resume Run** or **End Run** soft key. You may specify an infinite dwell time by pressing the **Shift** key, followed by the **0** key.

- **Repeat number:** Any cycle without an infinite dwell time may have 1 to 99 repeats.

4.3.2 Advanced Programming Options

4.3.2.1 Increment/Decrement Temperature

Most protocols call for the exact same temperature for each repeat of a cycle, but in some instances you may wish to program an automatic increase or decrease in the step temperature after each repeat. To input an automatic increment or decrement function for a step, the cycle containing the step must have more than one cycle repeat. The automatic increment and decrement function updates the set point temperature by a specified amount, after every repeat, starting after repeat one.

For example, you could create a cycle with 3 repeats, a step at 95°C, and a second step at 55°C. You could then specify a 0.5°C automatic temperature increment for the second step. Thus, on the first repeat of the cycle, the instrument would go to 95°C and then to 55°C. Then on the second repeat of the cycle, the instrument would go to 95°C and then to 55.5°C. Finally, on the third repeat of the cycle, the instrument would go to 95°C and then to 56.0°C.

Temperature increments or decrements may be as low as 0.1°C, and they may be as large as desired, so long as they do not result in values outside the legal ranges described in section 4.3.1. If you input an increment or decrement function that would result in an illegal temperature value, the thermal protocol will run, but the temperature will cease to increment or decrement once the upper or lower limit has been reached. Furthermore, for every repeat that would result in an illegal temperature value, an error is counted on the End of Run screen and displayed in the Validation and Run reports.

4.3.2.2 Increment/Decrement Time

Most protocols call for the exact same dwell time for each repeat of a cycle, but in some instances you may wish to program an automatic increase or decrease in the step dwell time after each repeat. To input an automatic increment or decrement function for a step, the cycle containing the step must have more than one cycle repeat. The automatic increment and decrement function updates the dwell time by a specified amount, after every repeat, starting after repeat one.

For example, you could create a cycle with 3 repeats, with a first step at 95°C for 10 seconds and a second step at 55°C for 45 seconds. You could then specify a 5-second automatic dwell time decrement for the second step. Thus, on the first repeat of the cycle, the instrument would hold at 55°C for 45 seconds. Then on the second repeat of the cycle, the instrument would hold at 55°C for 40 seconds. Finally, on the third repeat of the cycle, the instrument would hold at 55°C for 35 seconds.

Dwell time increments or decrements may be as low as 1.0 seconds, and they may be as long as desired, so long as they do not result in values outside the legal ranges described in section 4.3.1. If you input an increment or decrement function that would result in an illegal dwell time value, the thermal protocol will run, but the dwell time will cease to increment or decrement once the upper or lower limit has been reached. Furthermore, for every repeat that would result in an illegal dwell time value, an error is counted on the End of Run screen and displayed in the Validation and Run reports.

4.3.2.3 Temperature Gradient

The MyCycler Thermal Cycler offers a temperature gradient option for optimization of assay conditions. Gradients may be programmed at any step of any cycle of the protocol. The gradient option allows input of a temperature gradient of 1–25 degrees in total temperature span at temperatures as low as 30°C and as high as 99°C.

Thermal Gradients in the MyCycler are formed from the front to the rear of the sample block resulting in eight specific temperatures for assay optimization. This innovative design allows for evaluation of the maximum assay components at each specific temperature. Each row includes twelve wells for evaluation of assay components such as MgCl₂ or primer concentrations.

The temperature gradients formed by the MyCycler take a non-linear yet highly reproducible shape that allows for excellent prediction of actual sample temperatures at each row. Extensive validation of the gradient temperatures indicate that the non linear gradient is both predictable and reproducible.

4.4 Graphical Representation

Thermal protocols are displayed graphically as a temperature plot. The graphical representation shows a left-to-right plot of the thermal cycling program and reflects approximate values of the set point temperatures along its y-axis. The plot displays the set point temperature, dwell times, and advanced options, such as time or temperature increments and decrements, for each step.

At each step, the set point temperature in Celsius (e.g., 95.0°C) is shown immediately above the temperature plot, and the dwell time (in mm:ss format) is shown immediately below the temperature plot. Temperature increments and decrements are denoted within

the graphical display of a particular step, immediately above the set point temperature, and followed by a thermometer icon and an up-arrow for increments or a down-arrow for decrements. Time increments and decrements are denoted within the graphical display of a particular step, below the dwell time, and followed by a clock icon and an up-arrow for increments or a down-arrow for decrements.

Cycles are demarcated within the plot by vertical bars, and are labeled by cycle number in the bottom left corner of their first steps. The number of repeats for cycles are displayed in the bottom right corner of their last steps, e.g., 30 repeats would be displayed as "(30x)", and 1 repeat would be displayed as "(1x)". For cycles with an infinite hold, the "repeats" portion of the plot displays "(1x)".

The graphical representation of the protocol accommodates a maximum of five steps on the screen at any one time, even if this results in a partial display of a cycle. Cycle numbers and repeats are shown only in the first step of the cycle, whether or not this step gets cut off from the display. If the protocol continues off the left edge of the screen, a left arrow appears under the bottom left corner of the graphical display. Likewise, if the protocol continues off the right edge of the screen, a right arrow appears under the bottom right corner of the graphical display. In either case, if the protocol continues off the screen, you may use the left and right arrow keys to scroll through the protocol when viewing or editing a protocol.

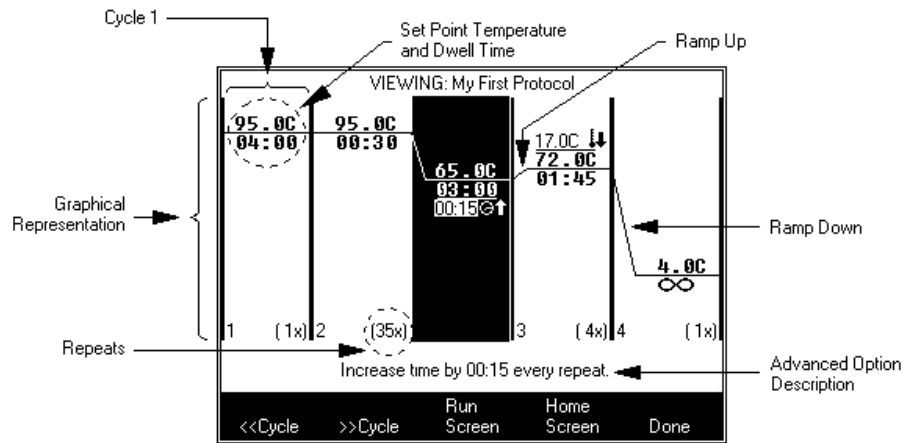

4.5 Viewing Protocols

You may view any protocol in the Protocol Library on the View screen, which displays a graphical representation of the protocol. While viewing the protocol, you may use the arrow keys and the Enter key to scroll through the protocol display. In addition, a textual display of any increment or decrement option for the currently selected parameter is shown at the bottom of the screen. Generally, the View screen serves only as a means to browse through an existing protocol. Therefore, no modifications can be made on the View screen.

4.5.1 Soft Key Functions for the View Screen

Softkey	Option	Description
F1	<<Cycle	Shifts the protocol display to the left by one cycle
F2	>>Cycle	Shifts the protocol display to the right by one cycle
F3	Run Screen	Displays the Run screen
F4	Home Screen	Displays the Home screen
F5	Done	Closes the View screen display

Section 5

Creating and Editing Protocols

To create a new protocol press F2 from the Home screen. You will be asked to select whether you wish to:

- Create a **Custom** Protocol: This is a completely new protocol you will define. If you choose **Custom**, a simple three-step, one cycle protocol is displayed. All editing options are available through the softkeys.
- Use one of the Bio-Rad protocols as a template. Section 4.2.2 contains a list of these protocols. You will be able to select from the individual protocols in the Bio-Rad folder. Some protocol names end with a 2 and others end with a 3; the number indicates the number of steps in the amplification cycle of that protocol. For either option you choose, you will need to enter values for time, temperature, and repeats, as described in the following sections.

To edit an existing protocol, press **F1** from the **Home** screen. You may then select the desired protocol from the **Protocol Library**, and then select the “Edit Protocol” option.

5.1 Specifying Time Values

Time values may fall between 1 second and 99 minutes-59 seconds. You must use the mm:ss format (e.g., 00:01 to 99:59.) When you input a value, the numbers will be entered from right to left with implied zeros in the front. For example, to enter 1 minute 15 seconds, press 1, 1, 5 followed by the **Enter** or an arrow key.

Note: entering a fifth digit will cause the left-most digit to be lost.

All protocols will have default values in each time field. If you want to accept the default value, press **Enter** or an arrow key. The **Clear** key may be used to remove all numbers in the time field.

5.2 Specifying Temperature Values

Temperature values must be in the range of 4.0°C to 100.0°C. Numbers are displayed on the screen as the keys are touched, beginning with the position immediately to the left of the decimal point, and then they move to the left with each subsequent entry. No decimal point will be displayed until you press the decimal point key, **Enter**, or one of the arrow keys. If the decimal point key is not pressed before the **Enter** key or an arrow key, then a decimal point and 0 are appended to the temperature automatically. For example, to enter 95.0°C, press 9, then 5 and an arrow or **Enter** key. The display will show 95.0 after the last keystroke. To enter 95.5°C, press 9, 5, decimal key (.), 5. **Note:** Entering a fourth digit will cause the left-most digit to be lost. Entering two digits after the decimal (.) will clear the entire field.

The **Clear** key may be used to remove all numbers in the temperature field.

5.3 Specifying Cycle Repeats

The number of cycle repeats may be between 1 and 99. The number of repeats is entered from right to left, similar to time and temperature values. For example, to specify 35 cycle repeats, enter 3, 5. **Note:** Entering a third digit will cause the left-most digit to be lost.

The **Clear** key may be used to remove all numbers in the cycle repeat field.

5.4 Creating and Editing Protocols: Advanced Options

When creating or editing a protocol, the system provides additional functionality in the use of the following:

- Temperature, Dwell Time, Temperature Gradient Options (**F3-Option**)
- Changing the Number of Cycles or Steps (**F4-Add/Del**)

5.4.1 Temperature and Dwell Time Options (F3-Option)

To add periodic increments or decrements to set point temperatures or dwell times, put the cursor on the temperature or dwell time that you want to affect and press **F3-Option**.



- If the cursor is on a temperature field when you press **F3-Option**, a menu will offer the choices **Constant Temp**, **Increment Temp**, and **Decrement Temp**, **Temp Gradient**, **Max Ramp Rate** and **Set Ramp Rate** (Figure X.X).
- If the cursor is on a dwell time field when you press **F3-Option**, the choices in the menu are **Constant Time**, **Increment Time**, and **Decrement Time**.
- If you press **F3** when the cursor is somewhere other than a temperature or dwell time field, a message will be displayed advising that no options are available for this item.

Increment/Decrement Temperature: When you select one of these options, a field will be displayed immediately above the set point temperature field. For temperature increments, a thermometer icon and an up arrow will appear next to the increment field. For temperature decrements, a thermometer icon and a down arrow will appear next to the decrement field. The specified value will be added to or subtracted from the set point temperature accordingly, for each repeat after repeat one.

Use the number keys to input a temperature increment or decrement value. You may set the increment or decrement as low as 0.1°C, and as large as you like, as long as the combination of the increment or decrement and the number of repeats does not result in a temperature outside the range of the MyCycler (4.0-100.0°C).

Increment/Decrement Time: When you select one of these options, a field will be displayed immediately below the dwell time field. For time increments, a clock icon and an up arrow will appear next to the increment field. For time decrements, a clock icon and a down arrow will appear next to the decrement field. The specified value will be added to or subtracted from the dwell time accordingly, for each repeat after repeat one.

Use the number keys to input a time increment or decrement value. You may set the increment or decrement as low as 1.0 seconds, and as long you like, as long as the combination of the increment or decrement and the number of repeats does not result in a dwell time outside the range of the MyCycler (00:00-99:59).

Constant Temp/Time: All optional features are reversible. To cancel a temperature increment or decrement, place the cursor on the set point temperature field or the temperature increment or decrement field and press **F3-Option**, then choose **Constant Temp** from the list box. Similarly, to cancel a time increment or decrement, place the cursor on the dwell time field or the time increment or decrement field and press **F3-Option**, then choose **Constant Time** from the list box. The set point temperature or dwell time will be made constant, and the increment or decrement field will be removed from the display.

Textual Display of Increments and Decrements: After adding an increment or decrement option for either a dwell time or a set point temperature, a brief textual description of the increment or decrement will appear at the bottom of the **Edit** screen. There are no editable or selectable fields within the textual display, although it automatically updates to match any option fields edited in the graphical display. For example, if you added a 30 second dwell time increment to a step and selected the increment field, the textual display would read, "Increase time by 00:30 every repeat." If the currently selected parameter contains no increment or decrement, then this portion of the screen is empty.

5.4.2 Temperature Gradient

The MyCycler Thermal Cycler offers a temperature gradient option for optimization of assay conditions. Gradients may be programmed at any step of any cycle of the protocol. The gradient option allows input of a temperature gradient of 1–25 degrees in total temperature span at temperatures as low as 30°C and as high as 99°C.

Thermal Gradients in the MyCycler are formed from the front to the rear of the sample block resulting in eight specific temperatures for assay optimization. This innovative design allows for evaluation of the maximum assay components at each specific temperature. Each row includes twelve wells for evaluation of assay components such as MgC1₂ or primer concentrations.

The temperature gradients formed by the MyCycler take a non-linear yet highly reproducible shape that allows for excellent prediction of actual sample temperatures at each row. Extensive validation of the gradient temperatures indicate that the non linear gradient is both predictable and reproducible.

Temp Gradient: To add a temperature gradient to your set-point temperatures, put the cursor on the desired temperature step of the protocol and press **F3-option**.

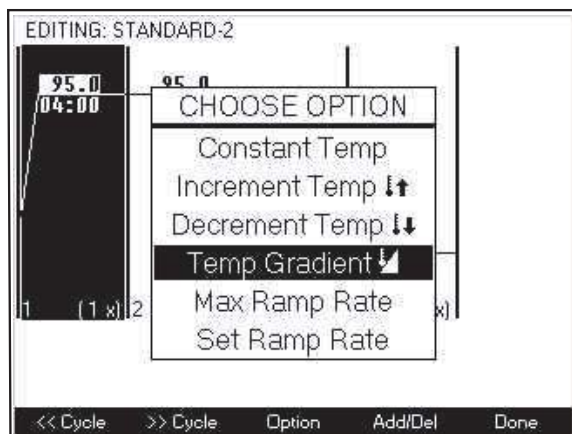

- From the menu, select **Temp Gradient**.
- Once selected, a default value of 1°C minimum-maximum gradient will be displayed. Input the desired range of the temperature gradient. The display will be updated with the temperatures for each row of samples. These values will be recorded in the run and validation reports (see Section 7). **Note:** The minimum gradient is 1.0°C; the maximum gradient is 25°C. The lowest available temperature within any gradient is 30°C; the highest allowable temperature within any gradient is 99°C.
- If the first temperature is higher than the second temperature, an error message will appear. The second temperature will be corrected to the nearest acceptable value. In addition, any input temperature out of the range of the acceptable values for gradient will be corrected to the nearest acceptable value.

5.4.3

Max Ramp Rate/Set Ramp Rate: The ramp rate is the speed with which the MyCycler changes temperatures between the steps of a cycle, or between cycles. The default condition is for the MyCycler to adjust temperatures at the maximum ramp rate with the minimum ramp time. The MyCycler allows you to change temperatures at a fixed rate less than the maximum (Ramp Rate). Ramp rates are adjustable to 0.1°C /sec. Ramp rates must fall within the range of 0.1 to 2.5°C per second for heating and 0.1 to 1.5°C per second for cooling.

To set the ramp rate, make sure a temperature is highlighted. Select Set Ramp Rate from the pull down menu of Option-F3. A black triangle will appear in the upper left corner and the default ramp temperature will appear below the graphical representation of the protocol. Using the key pad input the desired ramp rate then select enter. To edit a ramp rate, select the step in which the ramp rate has been changed. Highlight the black triangle in the upper left corner. Using the keypad, input the desired ramp rate then select enter. To return to the default maximum ramp rate value, select the step in which the ramp rate has been changed. Select Option-F3, choose Max Ramp Rate from the pull down menu then, select enter.

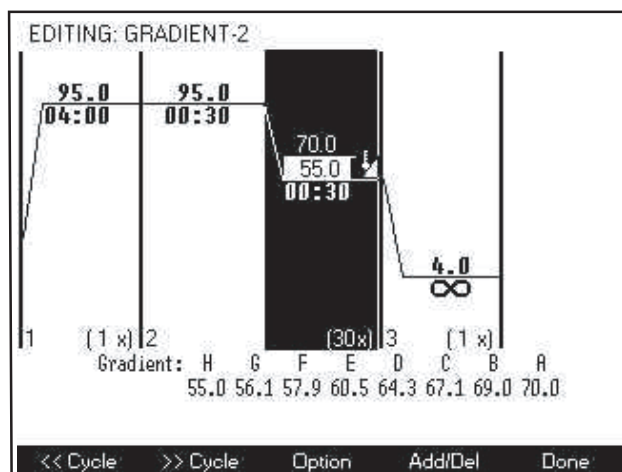

5.4.4 Changing the Number of Cycles or Steps (F4-Add/Del)

The **Add/Del** soft key (**F4**) allows you to change the number of cycles or steps. When **F4** is pressed, a menu of editing choices is displayed: **Add cycle before**, **Add cycle after**, **Add step before**, **Add step after**, **Delete step**, and **Delete cycle**. Steps and cycles are added before or after, relative to the current cursor position. If **Delete step** or **Delete cycle** is chosen, the step with the cursor, or cycle with the cursor, is deleted.

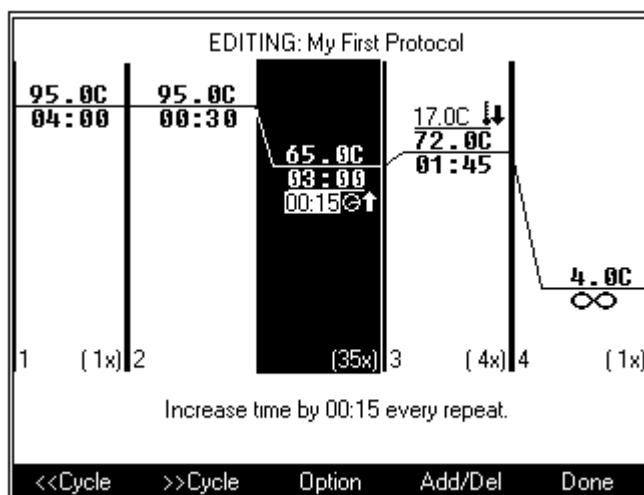

5.5 Soft Key Functions for the Edit Screen

Softkey	Option	Description
F1	<<Cycle	Shifts the protocol display to the left by one cycle
F2	>>Cycle	Shifts the protocol display to the right by one cycle
F3	Option	Adds or removes increments or decrements
F4	Add/Del	Adds or removes cycles and steps
F5	Done	Allows you to save, revisit, or reject changes made to the protocol. Also allows you to run the protocol without saving changes.

5.6 Completing Protocols

When you have finished editing the protocol, press **F5-Done** to display a menu of options. The choices are:

- **Run Protocol:** To run the protocol immediately, without first saving it. The **Run Setup** screen is displayed. This is documented in section 6.1.1.
- **Save Protocol:** To save changes made to an existing protocol. This option is unavailable when editing a Bio-Rad template protocol.

- **Save Protocol as...:** You will be asked to create a name for the protocol. You may then select the new protocol from the **Protocol Library** screen, as described in section 4.2.
- **Abandon Edits:** Reverts the protocol without saving changes.
- **Resume Editing:** Allows you to return to the protocol edit screen to make further changes.

The MyCycler can store up to 99 different protocol files in its on-board memory. File management is provided in the Protocol Library screen (refer to Section 4.2). The information stored in a protocol file will consist of:

- the time and temperature for each step of every cycle
- any gradient or automatic increment or decrement to the time or temperature for each step of every repeated cycle
- the number of times each cycle is repeated

5.7 Naming a Protocol

A protocol is given a name when:

- Selecting the “Save Protocol As...” option
- Selecting the “Rename Protocol” option

Protocols are named using the alphanumeric keys (see section 1.5 for details). A new protocol is saved as a file under the “My Protocols” column of the **Protocol Library**. Whenever the protocol is run, the name of the protocol appears on the **Run** screen and in the **Validation reports** and the **Run reports** for that run. All protocol files names must be unique.

Section 6 Running Protocols

6.1 How to Run a Protocol

To run a stored protocol:

1. From the Home screen press **F1** to display the Protocol Library.
2. Use the arrow keys to highlight the desired protocol.
3. Press **Enter** and from the selection box, choose **Run Protocol** and press **Enter**.
4. Confirm the selections in the Run Setup screen (hot start conditions, temperature measurement methods) and press **F5** to Start the Run. The Run Setup screen is documented below in section 6.1.1.

This symbol on the reaction module indicates a hot surface. The reaction module sample block may be hot to touch while the unit is running.

6.1.1 Run Setup Screen

When you choose to run a protocol, the Run Setup screen is displayed.

The screenshot shows the 'RUN SETUP' screen with the following fields and values:

- Protocol: (M) My First Protocol
- Temperature Measurement Mode: Algorithmic Measurement
- Sample Volume: 15-100 uL, with a value of 50
- Hot Start?: YES
- Hot Start Temperature (C): 95.0

Instructions at the bottom of the screen:

Use right/left arrows or Enter to move between fields.
Use up/down arrows to change selections.
Numeric keys may also be used for numeric field entries.

Buttons: Begin, Run

In this screen you can choose to specify

- **Hot Start and the hot start temperature:** If **Hot Start** is chosen, the MyCycler will heat to the hot start temperature when the run is initiated and then go into Pause mode. (See section 6.2.3.)
- **Temperature measurement mode:** This is the method of temperature measurement. You can choose to monitor the block temperature of the reaction module or the sample temperature by algorithm. If you choose the Algorithmic method, then you must specify the volume of the sample (**Sample Volume**).

When the Run Setup options are specified, press **F5-Begin Run**. Protocol execution will begin as soon as the heated lid reaches the appropriate temperature.

6.1.2 Run Screen

The Run screen will be displayed as the execution of the protocol begins. The Run screen displays the graphical representation of the protocol, with the set point temperature and dwell time of each step displayed on the graph. As each step is carried out, it is shown in inverse video.

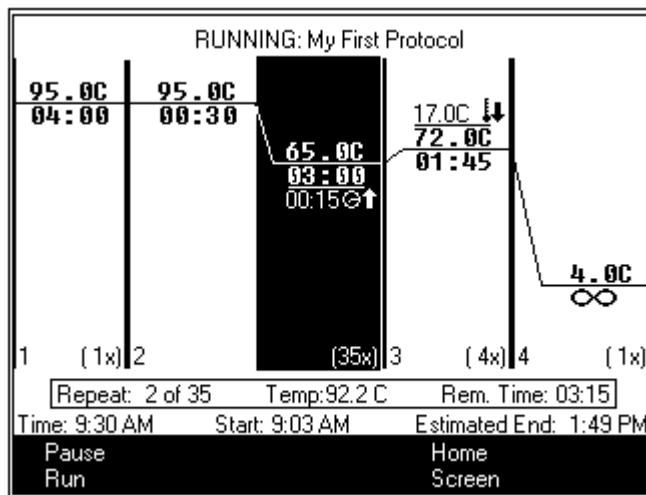

The screen also shows the current temperature of the reaction module block (when block monitoring mode is selected), or the calculated sample temperature (when the temperature is monitored via the algorithm mode). The current repeat number and dwell time of the current repeat will also be shown, and will count down as the protocol progresses.

The name of the protocol is displayed to the right of the word, "RUNNING:". If the protocol is an unsaved modification of a saved protocol, then the name of the saved protocol is displayed and preceded by the letter M (for modification) in parentheses.

The current time of day will be displayed along with the time the protocol was initiated, and with an estimated time of completion.

6.1.3 Running Gradient Protocols

The temperature gradient will appear in the graphical representation of the protocol. The maximum temperature, minimum temperature, and thermometer icon will be displayed for the gradient segment. This graphical presentation of the protocol appears in the run screen while the protocol is running.

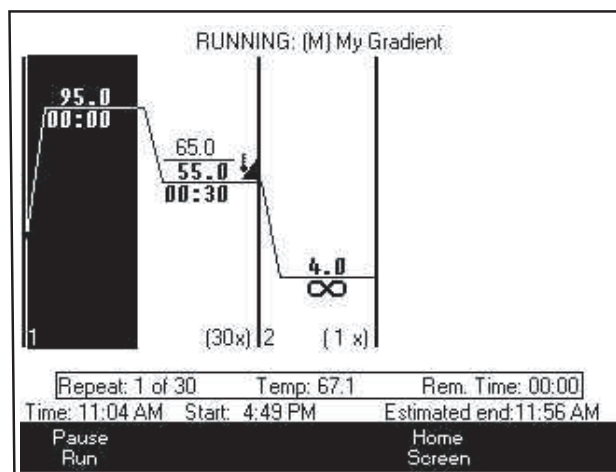

6.1.4 Converting a Gradient Protocol

The MyCycler Thermal Cycler allows the user to convert an existing gradient protocol to a non gradient protocol. To use the conversion feature, select the **F1-Option** to go to the **Protocol Library**. Select the gradient protocol that will be converted. From the **Choose Operation Menu** select **Convert Gradient**. A menu will appear that contains a temperature for each row of the gradient. Select the conversion temperature from the **Choose Row Menu**. Save the protocol with a unique name.

Please note that when a gradient protocol is converted to a non gradient protocol the ramp rates associated with the gradient protocol are transferred to the non gradient protocol. This is done so that the conversion of a protocol will produce an identical result. A black triangle in the upper left corner of a protocol step indicates that the ramp rate has been changed. When a step containing an altered ramp rate is highlighted the actual rate is shown below the protocol. For more details on changing ramp rates please review Section 5.4.3 in this manual.

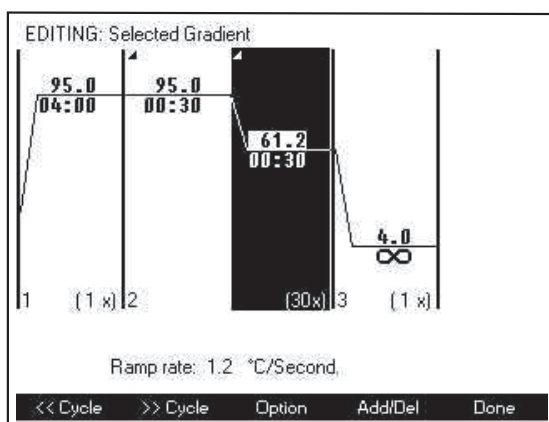
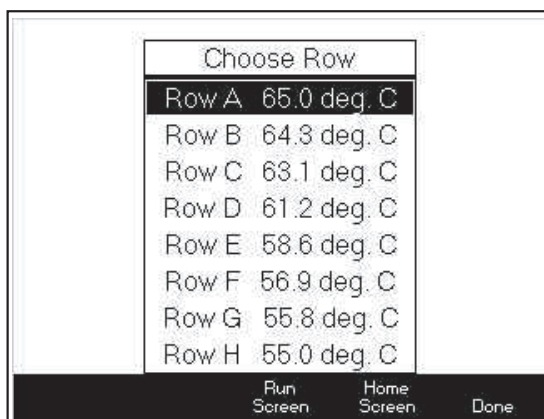

6.2 Options While a Protocol is Running

6.2.1 Displaying the Home Screen While a Protocol is Running

In the Run screen, pressing **F4-Home Screen** does not affect execution of the current protocol. From the Home screen, you will be able to perform other functions, including programming additional protocols. You may return anytime to the Run screen by pressing **F3-Run Screen**.

6.2.2 A Power Failure while a Protocol is Running

If a running protocol is interrupted by a power failure, the MyCycler will resume execution of the protocol automatically when power is restored. The protocol will resume at the step with the highest set point temperature of the cycle that was interrupted, on the same repeat that was interrupted. Each power failure is counted as an error at the end of the run, and is described in the Validation and Run reports.

If power is lost more than twice, the MyCycler will not resume execution of the protocol. If any single power interruption lasts longer than ten minutes, the protocol will not resume.

6.2.3 Pausing a Running Protocol

When the **STOP** key or the Pause (F1) soft key is pressed while a protocol is running, the MyCycler will go into Pause mode and the temperature of the reaction module block will be brought to the next set point temperature and held there. If the MyCycler is counting down a dwell time when the **STOP** or Pause soft key is pressed, it maintains the temperature and the clock stops. The soft key options are Resume or End the running protocol. If you choose:

- **F1-Resume Run:** The clock will immediately begin counting down the dwell time or resume counting down at the point at which the protocol was paused.
- **F2-End Run:** The instrument will be heated or cooled to the idle temperature, and you will return to the Home screen.

6.2.4 Terminating a Running Protocol

To terminate execution of a protocol before it has been completed, go into Pause mode, as described above, and select **F2-End Run** or press Stop key.

6.2.5 End of Run Screen

The End of Run screen is automatically displayed after protocol execution. It will offer soft key options for getting reports on the protocol. These reports are discussed in the following section. If there was any problem with the execution of the protocol, a message to that effect will be displayed along with the appropriate instructions (e.g., Call your Bio-Rad representative.)

Section 7 Reports

Reports are textual summaries that record the details and settings of protocols run on the MyCycler. These reports are stored in the instrument memory for 30 days and cannot be deleted. Following the end of every protocol, both a **Validation Report** and a **Run Report** are made available by pressing **F2-Run Report** or **F3-Validation Report** from the **End of Run** screen. Furthermore, you may also access an index of every protocol run for the past 30 days from the **View Reports** option in the **Utilities** menu, and you may choose to view the reports for any listed run.

7.1 The Run Report

The **Run Report** is a subset of the information contained in the **Validation Report**. The Run Report does include the settings of the instrument and protocol, but does not track the execution of every step, cycle, and repeat of the protocol.

Both the Run Report and the Validation reports include the following details:

- Protocol name
- Date of run
- The time at which the protocol started
- The time at which the protocol ended
- The serial number of your instrument
- The **Instrument Name** at the time of the run
- The thermal cycling protocol, in text
- The **Temperature Measurement Mode** selected for the run
- The **Sample Volume** selected for the run if **Algorithmic Measurement Mode** was specified
- The Validation Report summary, which lists the total number of **exceptions** and **errors**.
- Ramp Rates of Gradient Steps.

7.2 The Validation Report

The Validation Report includes all the details of the Run Report, but also includes a list of every step, cycle, and repeat of the protocol, flagged as OK, Exceptions, or Errors, as follows:

- **OK**: Signifies that the instrument successfully attained the correct set point temperature, and held it for the correct amount of time. The step will have an "OK" appended to it.
- **Exceptions and Errors**: Signifies that an exception or error has occurred, or the user has intervened with the progress of the protocol. Exceptions and Errors are denoted in the Validation Report with a "***" flag.

7.3 Soft Key Functions for Reports

Softkey	Option	Description
F1	Begin	Brings the display to the first line of the report
F2	PageUp	Scrolls the report display up by one page
F3	PageDown	Scrolls the report display down by one page
F4	End	Brings the display to the last line of the report
F5	Done	Closes the report display

7.4 Uploading Reports

An external utility is available to upload Run and Validation reports from the MyCycler to a PC computer system. This utility is included on the CD ROM that is shipped with all MyCycler systems. This utility will work with Windows 98, Windows 2000, Windows XP and Windows ME. It will not work with Windows NT because that operating system has no native support for USB.

To install the Upload Utility:

1. Insert the Installation CD into a CD ROM drive.
2. Select Run... from the Start menu.
3. Type X:\Setup where X is the drive letter of the CD ROM drive.
4. Follow the instructions on the screen to complete the installation. A folder called Report Utility will be created in the MyCycler folder.

To upload reports to the PC:

1. Connect the MyCycler to the PC using the supplied USB cable.
2. Select Start → Programs → MyCycler → Report Utility.
3. Select the type of Report to upload.
4. Click on the report name on the left side of the screen to see the report displayed on the right side of the screen.
5. To save the report, click **Save to File**. Enter a valid filename in the dialog box, followed by .TXT.
6. Click **Save**. Files are saved in plain text format and can be easily reopened and printed using a word processor program such as Word.

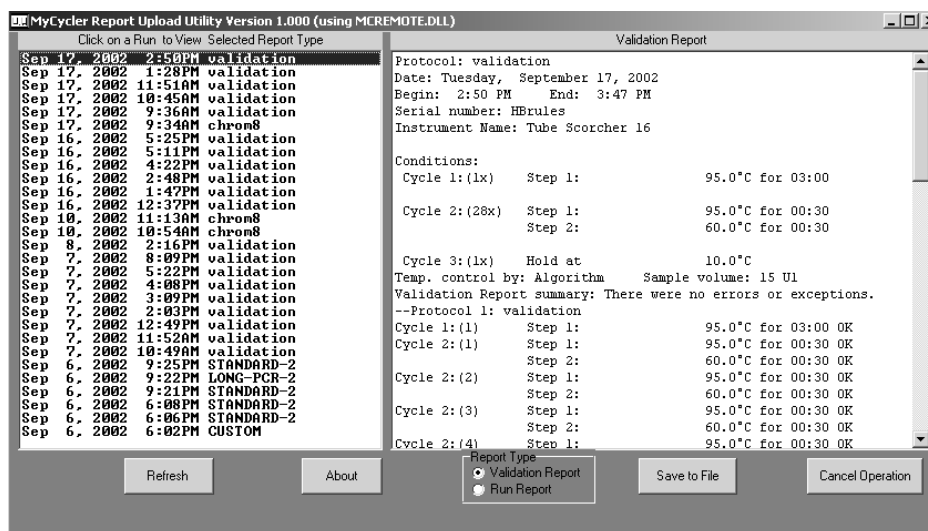

Section 8 Utilities

You can access the **Utilities** menu by pressing **F4-Utilities** from the **Home** screen. The **Utilities** menu provides access to basic, miscellaneous options related to instrument operation and access to the **Set Preferences** menu, which is a sub-menu containing additional options related to preferences and instrument defaults.

8.1 The Utilities Menu

The **Utilities** menu contains the **Set Preferences** option (See Section 8.2 **Set Preferences Menu**) as well as the following options:

8.1.1 View Reports

Choose this option to browse through an index of past runs and to view individual **Validation Reports** and **Run Reports**. The runs are stamped and sorted by date and time, with the most recent runs listed at the top of the list.

8.1.2 Instrument Information

Choose this option to display the **Instrument Name**, serial number, firmware version, and the number of user-defined protocols saved to memory.

8.1.3 Set Date and Time

Choose this option to set the current date and time. The changes you make will not be saved unless you press **F5-Accept Changes**. You may press **F1-Cancel** at any time to cancel the changes you have made and to close the **Set Date and Time** display.

8.1.4 Set Display Contrast

Choose this option to adjust the display contrast of the LCD screen. The changes you make will not be saved unless you press **F5-Accept Changes**. You may press **F1-Cancel** at any time to cancel the changes you have made and to close the **Set Display Contrast** display.

8.1.5 Service Options

For Bio-Rad internal use only.

8.2 Set Preferences Menu

The **Set Preferences** menu, which is accessed from the **Utilities** menu, contains the following options:

8.2.1 Default Hot Start Options

Choose this option to set the default **Hot Start?** and **Hot Start Temperature** settings as they appear on the **Run Setup Screen**. The changes you make will not be saved unless you press **F5-Accept Changes**. You may press **F1-Cancel** at any time to cancel the changes you have made and to close the **Default Hot Start Options** display.

8.2.2 Default Temperature Measurement Mode

Choose this option to set the default **Temperature Measurement Mode** as it appears on the **Run Setup Screen**. The changes you make will not be saved unless you press **F5-Accept Changes**. You may press **F1-Cancel** at any time to cancel the changes you have made and to close the **Default Temperature Measurement Mode** display.

8.2.3 Default Sample Volume

Choose this option to set the default **Sample Volume** as it appears on the **Run Setup Screen**. The changes you make will not be saved unless you press **F5-Accept Changes**. You may press **F1-Cancel** at any time to cancel the changes you have made and to close the **Default Sample Volume** display.

8.2.4 Idle Temperature Mode

Choose this option to specify the temperature control mode in between protocols. You may choose to turn off all temperature control when the instrument is idle and allow it to come to ambient temperature, or you may choose to maintain a particular Idle Holding Temperature. The changes you make will not be saved unless you press **F5-Accept Changes**. You may press **F1-Cancel** at any time to cancel the changes you have made and to close the **Idle Temperature Mode** display.

8.2.5 Lid Temperature Control

Choose this option to specify the heated lid control. You may choose between the following options:

- Set lid temperature to any value from 100°C to 110°C or turn off lid temperature control completely.
- Set the lid temperature to 40°C or turn off lid temperature control completely when block temperature is below 25°C.

Press **F5-Accept Changes** to save changes or press **F1-Cancel** at any time to cancel the changes and to close the **Lid Temperature Control** display.

Note: We do not advise turning off lid temperature control when the block is at 25°C or higher, since this will cause evaporation of the samples in most cases.

8.2.6 Auto-Standby Options

Choose this option to enable or disable the **Auto-Standby** feature for your MyCycler, and to specify the **Length of Idle Time Before Auto-Standby** within the range of 1 minute to 9 hours and 59 minutes. The changes you make will not be saved unless you press **F5-Accept Changes**. You may press **F1-Cancel** at any time to cancel the changes you have made and to close the **Auto-Standby Options** display.

The instrument is considered not in use when it is not running a protocol, not receiving input from the keypad, not holding temperature for an infinite dwell time, or not holding a protocol with unsaved changes in memory.

When Auto-Standby is enabled, the instrument will go into standby mode following the specified period of non-use. The instrument is considered not in use when the instrument is not running a protocol, is not receiving input from the keypad, is not holding a temperature for an infinite dwell time. The advantage to enabling Auto-Standby mode is that the instrument saves power while in standby mode. To wake the instrument from standby mode, simply press the **Standby** button once. Upon waking from Standby mode, the **Home** screen is displayed.

8.2.7 Instrument Name

Choose this option to input a new **Instrument Name** for your MyCycler. The name may consist of up to 20 characters. The instrument name cannot be blank. The new Instrument Name will be displayed on the **Home** screen as well as in **Validation Reports** and **Run Reports** for subsequent runs.

8.2.8 Beeper Options

Choose this option to set the instrument to make a particular sound for a number of different occasions.

- **End of Run:** Sets the beep option for whenever a protocol ends
- **Error:** Sets the beep option for errors
- **Alert:** Sets the beep option for warnings
- **Key Click:** Set to enable or disable audible key presses
- **Volume:** Sets the volume of the beeper

The changes you make will not be saved unless you press **F5-Accept Changes**. You may press **F1-Cancel** at any time to cancel the changes you have made and to close the **Beeper Options** display. You may also press **F2-Test** to sound the beeper with the currently selected volume and tone settings.

Section 9 The Help Screen

The **Help** screen provides onboard help and information, and is displayed when you hit **F5-Help** from the **Home** screen. From the Help screen, you may browse through a list of different help topics, which are sorted by category. Use the up and down **arrow** keys to select a topic, and then press the **Enter** or **F4-Display** key to display the information on that help topic.

9.1 Soft Key Options for the Help Screen

- **F1-Previous:** Selects the previous topic listed in the help index
- **F2-Next:** Selects the next topic listed in the help index
- **F4-Display/Index:** When viewing the index of help topics, this softkey is labeled “Display”, and pressing this button displays the information on the selected help topic. When viewing the information on a help topic, this softkey is labeled “Index”, and pressing this button takes you back to the index of help.
- **F5-Done:** Brings the display back to the **Home** screen.

Section 10 Care and Maintenance

10.1 Cleaning the Unit

You should ensure that no liquid is spilled onto or into the MyCycler. In addition, periodically wipe it clean of dust and other residue that comes with normal operation of the instrument. Use a soft, lint-free cloth and de-ionized water.

10.2 Replacing a Fuse or Battery

The fuse is located on the rear panel of the instrument. If the MyCycler does not turn on (as indicated by its LED located on the front panel of the instrument) when plugged in and the power button is pressed, the fuse may need to be replaced. To replace the fuse:

1. Disconnect the power cord from the unit.
2. Remove the fuse holder from the rear panel of the instrument with a small flat-head screwdriver or similar tool.
3. Pull the fuse holder out and replace the old fuse with one having the correct current rating:
 - a. For 100–120 V operation: Use 8.0A, 5 x 20 mm, Type T fuses.
 - b. For 220–240 V operation: Use 4.0A, 5 x 20 mm, Type T fuses.
4. Reinsert the fuse holder into the rear panel of the instrument, and press the fuse holder gently until it snaps into place.
5. Insert the power cord plug into the power entry module. Plug the power cord into a properly grounded outlet.

The battery will need to be replaced if the time and date do not remain set after the unit is turned off. The battery is a 3V lithium coin cell (battery number CR2077; Bio-Rad catalog #900-1228.) To replace the battery:

1. Disconnect the power cord.
2. Turn the MyCycler over so that the bottom faces up. Locate the access panel at the bottom of the front. Loosen the screw and remove the panel.
3. Remove the old battery and replace it with a new battery. A small flat-head screwdriver may be used to aid removal. The (+) battery terminal (flat side) must face outwards.
4. Replace the access panel on the bottom of the instrument and tighten the screw.
5. Reconnect the power cord.

10.3 Troubleshooting Procedure

Problem	Cause	Solution
No power (front panel LED does not light)	Blown fuse in power entrymodule	Replace fuse
	Bad power cord	Replace cord
	Circuit tripped	Check outlet, reset breaker
Fuse blows repeatedly	Wrong fuse installed	Check line voltage and install the correct fuse type as described in section 1.3.2
Will not go to 4 degrees	Ambient temperature too hot	Move to cooler location (see specifications)
Condensation on the tops of tubes or plates menu	Lid heater turned off	Check lid heater preferences in Set Preferences
	Lid heater failed	Call Bio-Rad
Lid heater does not work	Loose cable connection or instrument failure	Call Bio-Rad
Crushed tubes	Not enough tubes in block	Add 10 extra empty tubes
LCD too light or dark	Poor Adjustment	Adjust as described in Section 8.1.4
LCD panel blank, but fan runs	LCD failure, loose cable	Call Bio-Rad
No fan, but LCD panel on	Loose fan cable, Failed fan	Call Bio-Rad
Time and date are not retained when power is off	Dead battery	Replace battery. See Section 10.2.
“Operation Not Possible” message	Bad LED circuit	Call Bio-Rad

10.4 Error Messages

Message	Cause
No operations allowed for selected item. Press Enter key.	You pressed an inappropriate key for the selected item.
Out of range entry corrected to the nearest valid value!	Time or Temperature values were outside allowed ranges.
Infinite time invalid in repeated cycles	If a cycle is repeated, you may not specify an infinite dwell time within the cycle.
Only nine cycles are allowed in a protocol.	Programming a protocol with more than nine cycles
Only nine steps are allowed in a cycle.	Programming a protocol with a cycle containing more than nine steps
No options available for this option.	Pressing the option softkey when neither a temperature nor time field is selected
Note: The previous run had exceptions. Press Enter key.	Errors were detected in execution of the last protocol.
Cannot start run. Run currently in progress. Press Enter key.	A protocol is currently being executed.
There is no available space to save new protocols! Press Enter key.	The 99 user-defined protocol storage limit has been reached.
No changes are allowed to the Bio-Rad protocols! Press Enter key.	You may not delete or overwrite Bio-Rad template protocols.
Error: Name is blank!	You pressed Enter prior to naming a protocol.
Error: Name in use. Please use a different name. Press Enter key.	A protocol with the same name already exists.
Incorrect password entered.	Service Options are for Bio-Rad internal use only

Appendix A Specifications

Input Power	
100–120 VAC	100-120 VAC; $\pm 10\%$; 50–60 Hz Fuse: 8.0 A; 5 x 20 mm; Type T
220–240 VAC	220-240 VAC; $\pm 10\%$; 50-60 Hz Fuse: 4.0 A; 5 x 20 mm; Type T
Power	670 Watts; 910 VA (max.) 200 Watts (typical)
Environmental	
Operating	18–28°C
Ambient Storage	-20°C to 60 °C
Block Temperatures	
Range	4–100°C
Cycling Speed	with 20ul sample in a 0.2 ml tube, after full warm up, when cycling between 50°C and 95°C; at least 2.5°C/sec maximum heating rate and 1.5 °C/sec maximum cooling rate.
Storage Cooling	Less than 3 minutes to cool from 40°C to 4°C
Overshoot	less than 0.5°C
Accuracy	$\pm 0.5^\circ\text{C}$ to NIST traceable standard after 30 seconds at 90°C, block mode
Uniformity	Well-to-well uniformity of $\pm 0.5^\circ\text{C}$ within 30 seconds after arrival at 90°C.
Temperature Gradient	
Input Gradient Range	1–25°C
Functional Gradient Range	5–25°C
Minimum Temperature of Gradient	30°C
Maximum Temperature of Gradient	99°C
Gradient Accuracy	+/-0.5
Gradient Uniformity	+/-0.5
Descriptive Specifications	
Dimensions, Chassis (HxWxD)	20.5 x 23.6 x 44.3 cm (8.1 x 9.3 x 17.5")
Weight	10 kg (22 lbs.)
Sample Capacity/ Sample Size	96 wells/ 0.2 ml each
Display	LCD high resolution screen
Chassis	ABS plastic

Programming Specifications

No. of Programs	99 on board
Cycles/Protocols	up to 9
Steps/Cycles	up to 9
Repeats/Cycle	up to 99
Dwell Time	00:01-99:59 minutes
Pause	Yes
Built-in Protocols	Templates for cycling sequencing, Touchdown, RT PCR, Nested PCR, Gradient temperature PCR, long PCR

Regulatory

PCR Licenses	Authorized Thermal Cyclers Note: Use of the MyCycler with authorized reagents also provides a limited PCR license in accordance with the label rights accompanying such reagents. Some applications may require licenses from other parties.
--------------	--

Safety	EN-61010, TUV approved
--------	------------------------

EMC	Compliance with EN61326 + A1
-----	------------------------------

Communications

	USB ports
--	-----------

Electrical Approvals

	TUV
--	-----

Appendix B

Product Information

Catalog Number	Product Description
170-9703	MyCycler Thermal Cycler System , includes the MyCycler Thermal Cycler, and a box of 0.2 ml Thin Wall Tubes (catalog 223-9473)
TWI-0201	0.2 ml Tubes With Domed Caps , natural, 1,000
TFI-0201	0.2 ml Tubes With Flat Caps , natural, 1,000
TBS-0201	0.2 ml 8-Tube Strips Without Caps , natural, 125
TCS-0801	Domed 8-Cap Strips , for 0.2 ml tubes and plates, natural, 120
TCS-0803	Optical Flat 8-Cap Strips , for 0.2 ml tubes and plates, ultraclear, 120
TBS-1201	0.2 ml 12-Tube Strips Without Caps , natural, 100
TCS-1201	Domed 12-Cap Strips , for 0.2 ml tubes and plates, natural, 200
MLP-9601	Multiplate 96-Well 0.2 ml Unskirted PCR Plates , natural, 25
MSB-1001	Microseal 'B' Adhesive Seals , 100
223-9442	96-Well PCR Plate Sealing Mats , 5
170-8870	<i>iTaq</i> DNA Polymerase , includes 250 U polymerase, 10x PCR buffer and MgCl ₂ solution
170-8872	MgCl₂ Solution , 1.25 ml of 50 mM MgCl ₂
170-8874	dNTP Solution , 200 µl of 10 mM of each dNTP



**Bio-Rad
Laboratories, Inc.**

Life Science
Group

Web site www.bio-rad.com **USA** (800) 4BIORAD **Australia** 02 9914 2800 **Austria** (01)-877 89 01 **Belgium** 09-385 55 11 **Brazil** 55 21 2527 3454
Canada (905) 712-2771 **China** (86 21) 6426 0808 **Czech Republic** + 420 2 41 43 05 32 **Denmark** 44 52 10 00 **Finland** 09 804 22 00
France 01 47 95 69 65 **Germany** 089 318 84-0 **Greece** 30 210 777 4396 **Hong Kong** (852) 2789 3300 **Hungary** 36 1 455 8800
India (91-124)-2398112/3/4, 5018111, 6450092/93 **Israel** 03 951 4127 **Italy** 39 02 216091 **Japan** 03-5811-6270 **Korea** 82-2-3473-4460
Latin America 305-894-5950 **Mexico** 55-52-00-05-20 **The Netherlands** 0318-540666 **New Zealand** 64 9 415 2280 **Norway** 23 38 41 30
Poland + 48 22 331 99 99 **Portugal** 351-21-472-7700 **Russia** 7 095 721 1404 **Singapore** 65-64153188 **South Africa** 00 27 11 4428508
Spain 34 91 590 52 00 **Sweden** 08 555 12700 **Switzerland** 061 717 95 55 **Taiwan** (886 2) 2578 7189/2578 7241 **United Kingdom** 020 8328 2000

Sig 1204

4006219 Rev F